

The **multiboard** that we offer is a circuit board developed for quick and uncomplicated construction using individual parts and prototypes. The soldered side is divided into many copper areas, each measuring approx. 10 * 10 mm.

The components are glued directly onto the solder side and the connection wires are soldered to the copper surface

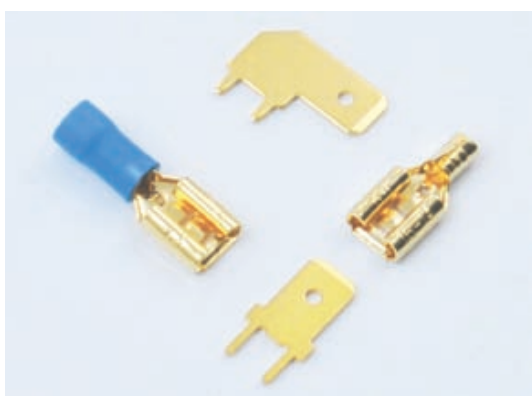
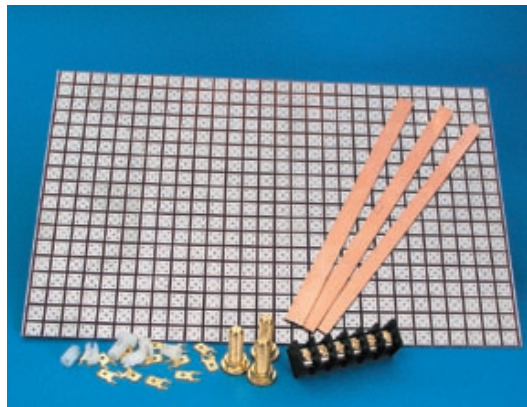

BLADE8.RDD

Blade receptacles, 0,5-1,5mm² cable, red

	12 pcs [€]	144 pcs [€]
2,8G gold-plated	2,99	19,90
4,8G gold-plated	2,99	19,90
6,3G gold-plated	2,99	19,90

BLADE8.RBL

Blade receptacles, 1,5-2,5mm² cable, blue

	12 pcs [€]	144 pcs [€]
2,8G gold-plated	2,99	19,90
4,8G gold-plated	2,99	19,90
6,3G gold-plated	2,99	19,90

BLADE8.RYE

Blade receptacles, 4,0-6,0mm² cable, yellow

	12 pcs [€]	144 pcs [€]
6,3G gold-plated	5,99	39,90

Available accessories include:

- Gold-plated connection terminals (see also p. 68) for the connection of the cable.
- Gold-plated solder posts for the connection of the cable. (see also p. 68)
- SilverGold wire for inner wiring (see also p. 60)
- Copper strips for the production of connections.

UNIP11

Universal circuit boards, 283 * 182 mm

[€]
32,90

UNIP12

Universal circuit boards, 182 x 141 mm

[€]
18,90

UNIP13

Universal circuit boards, 94 * 182 mm

[€]
13,90

UNIP14

Universal circuit boards, 141 * 91 mm

[€]
9,49

UNIP18

Universal circuit boards, 91 * 70 mm

[€]
4,99

CU300

Copper strips approx. 300mm

h*w [mm]	[€]
1-5	1,19
1-10	1,49
1-15	1,99

These **circuit board terminals** make a simple screw connection between the circuit board and the cabling possible. They are particularly well suited for use in connection with our crossover component casings.

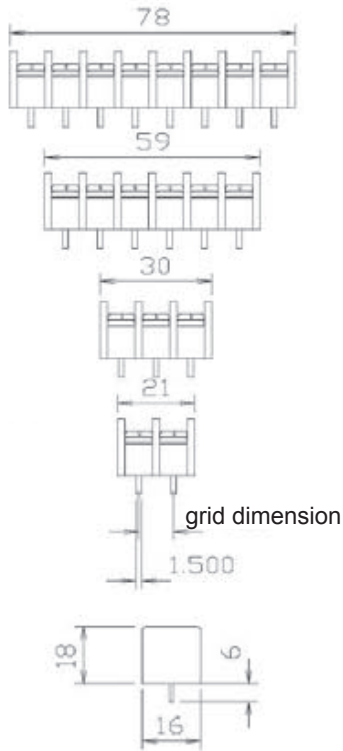

CBST82
Circuit board posts, 8,2mm grid dimension

Description		[€]
2N	2-pin, nickel-plated	1,99
3N	3-pin, nickel-plated	2,49

CBST92
Circuit board posts, 9,2mm grid dimension

Description		[€]
2G	2-pin, gold-plated	1,99
3G	3-pin, gold-plated	2,49
6N	6-pin, nickel-plated	3,49
6G	6-pin, gold-plated	3,49
8N	8-pin, nickel-plated	3,99
8G	8-pin, gold-plated	3,99

MCONCBR
Mconnect connection bridge, red

	[€]
	2,49

MCONSPG
MConnect solder pin, gold-plated

	[€]
	0,79

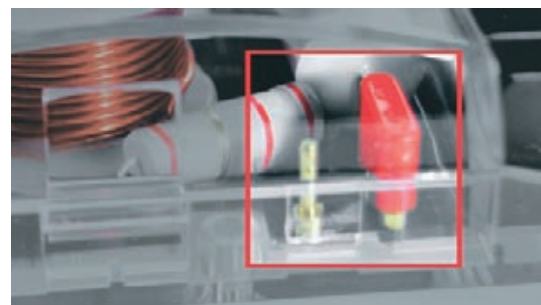



carg2 (without components)

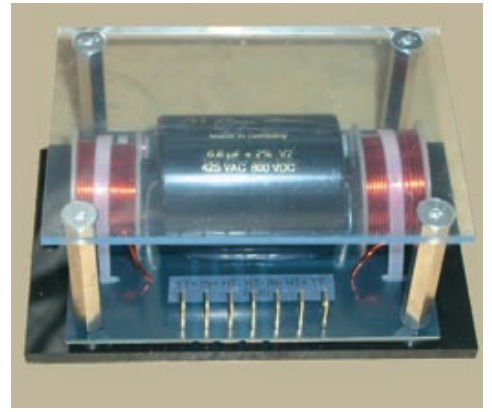

cargind

Our beautifully shaped casings can be used for the support of individual frequency separating filters, in particular for CarAudio applications.

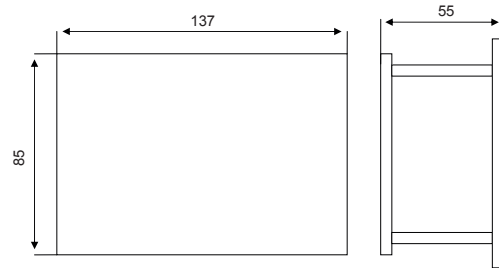
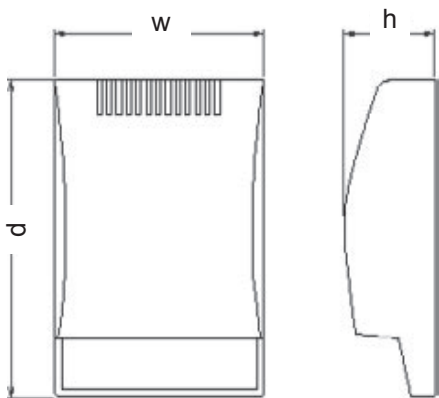

Casing	w [mm]	h [mm]	d [mm]
CARG2	85	37	130

CARG2
cross-over casings

[€]
4,99

CARGIND
cross-over casings

[€]
9,99